

**CTL Chromebook NL71/
CTL Chromebook NL71-L/
CTL Chromebook NL71CT/
CTL Chromebook NL71CT-L**

USER MANUAL

ENGLISH

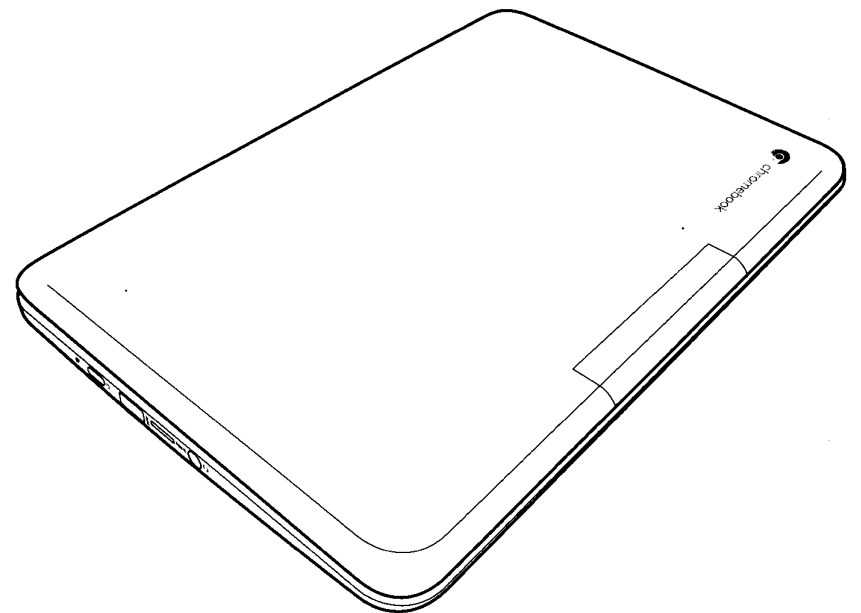

HDLI9013010 3B

April 2020

CONTENTS

BEFORE YOU START	4
Make sure you have everything	4
Familiarize yourself with the computer	5
OPENING THE DISPLAY PANEL	5
FRONT OVERVIEW.....	6
LEFT SIDE OVERVIEW.....	8
RIGHT SIDE OVERVIEW	10
BACK OVERVIEW	13
BOTTOM OVERVIEW.....	13
GETTING STARTED	15
Power Sources	15
CONNECTING THE POWER ADAPTERS	15
RECHARGING THE BATTERY	16
Starting Your Chromebook	17
POWER ON	17
POWER OFF	17
USING SHORTCUT KEYS	18
USING THE TOUCHPAD	20
TROUBLESHOOTING	22
Identifying the Problem	22
REGULATORY NOTICES	23
SPECIFICATIONS	28

TAKING CARE OF YOUR COMPUTER

- To prevent possible overheating of the computer's processor, make sure you don't block the openings provided for ventilation.
- **DO NOT** press or touch the display panel.
- **DO NOT** place on uneven or unstable work surfaces.
- **DO NOT** use your computer under harsh conditions.
- **DO NOT** place or drop objects on the computer and **DO NOT** apply heavy pressure on it.
- **DO NOT** subject the computer to magnetic fields.
- **DO NOT** expose to direct sunlight.
- **DO NOT** use or store in extreme temperatures.
- Avoid sudden changes in temperature or humidity by keeping it away from A/C and heating vents.
- Avoid exposing the computer to rain or moisture.
- **DO NOT** place near fire or other sources of heat.
- **DO NOT** tamper with the batteries. Keep them away from younger children.
- **DO NOT** expose to dust and/or corrosive chemicals.
- **DO NOT** slam your computer shut and never pick up or hold your computer by the display.
- **DO NOT** spray water or any other cleaning fluids directly on the display.
- If you are traveling with your computer, remember to carry it as hand luggage. Do not check it in as baggage.

BEFORE YOU START

Make sure you have everything

When you receive your Chromebook, unpack it carefully, and check to make sure you have all the items listed below. For a pre-configured model you should have the following:

- Chromebook
- AC adapter with power cord
- User Manual

Once you have checked and confirmed that your Chromebook system is complete, read through the following pages to learn about all of your Chromebook components.

NOTE

Depending on the model you purchased, the actual appearance of your Chromebook may vary from that shown in this manual.

Familiarize yourself with the computer

OPENING THE DISPLAY PANEL

To open the display panel, simply lift the lid up.

When closing it, be sure not to slam it shut.

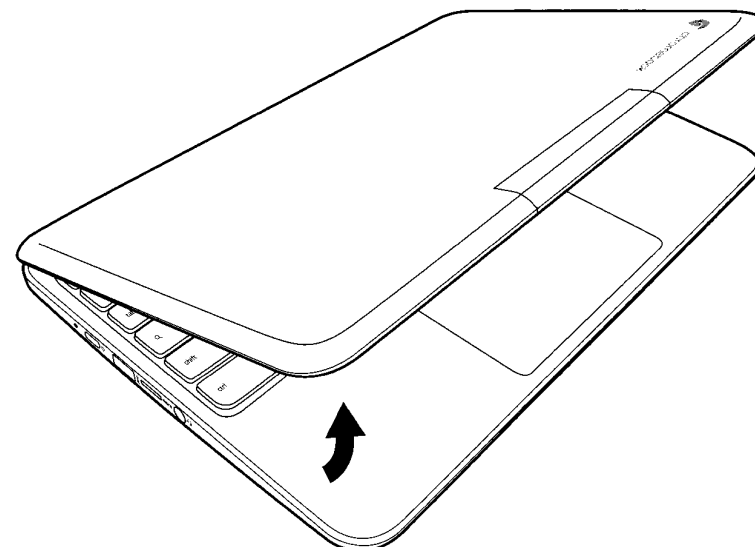

FRONT OVERVIEW

The following is an overview of the front of the Chromebook.

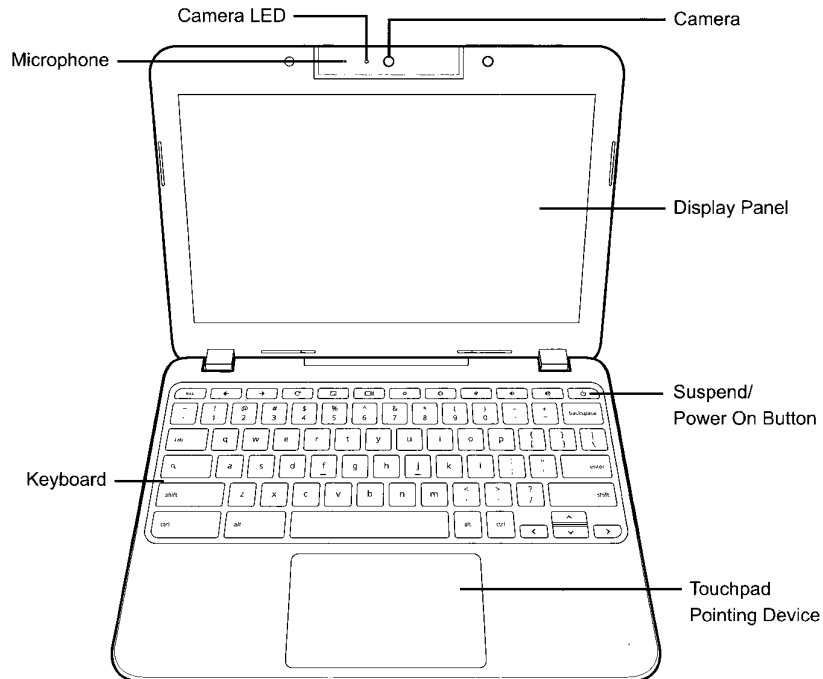
**Microphone**

The built-in microphone allows for the reception and transmission of voice and/or other audio data to any program capable of accepting such input.

Camera

The 720p HD rotatable camera allows you to snap a photo or create a video chat or video conference from different angles.

Display Panel

The display panel is a color LCD panel with back lighting for the display of text and graphics.

Suspend/Power On Button

This button turns your Chromebook on and off. (See Power On section for more information.)

Touchpad Pointing Device

The touchpad pointing device is a mouse-like cursor control with a touch sensitive movement pad.

Keyboard

The standard Chromebook keyboard is equipped with special shortcut keys which help you access common actions quickly. It is also spill resistant to offer users protection from accidental liquid spills.

Camera LED

The camera LED indicates when the camera is enabled or disabled.

LEFT SIDE OVERVIEW

The following is a brief description of the left side of the Chromebook.

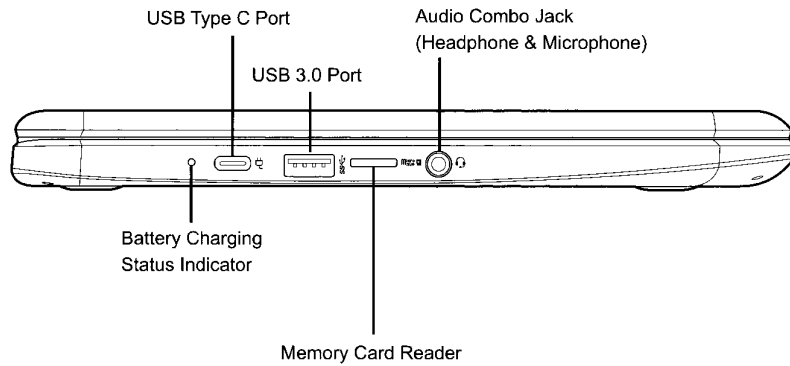

USB Type C Port

The USB Type C port allows you to connect Universal Serial Bus devices. It is small, compact, and reversible port.

USB 3.0 Port

The USB 3.0 port allows you to connect Universal Serial Bus devices. It supports v3.0 of the USB standard, which allows data exchange rates as high as 4.8 Gb/s. USB 3.0 is backwards compatible with USB 2.0.

Audio Combo Jack (Headphone & Microphone)

The audio combo jack allows you to connect headphones, external speakers, amplifiers or an external mono microphone.

Memory Card Reader

The memory card reader offers a fast and easy way to transfer digital photos, music and data between your Chromebook and flash compatible devices such as digital cameras, portable MP3 players, mobile phones, tablets, and handheld devices.

Battery Charging Status Indicator

The battery charging status indicator shows the system battery status in the following manner:

- Amber light - The battery is charging.
- Blue light - The battery is fully charged.

RIGHT SIDE OVERVIEW

The following is a brief description of the right side of the Chromebook for three different SKUs: USB, HDMI, and LTE.

USB SKU:

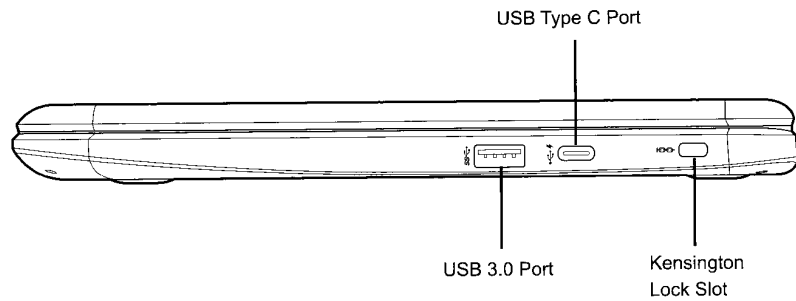

HDMI SKU:

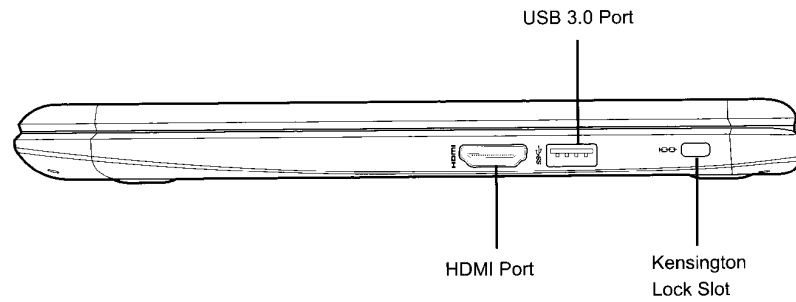

LTE SKU:

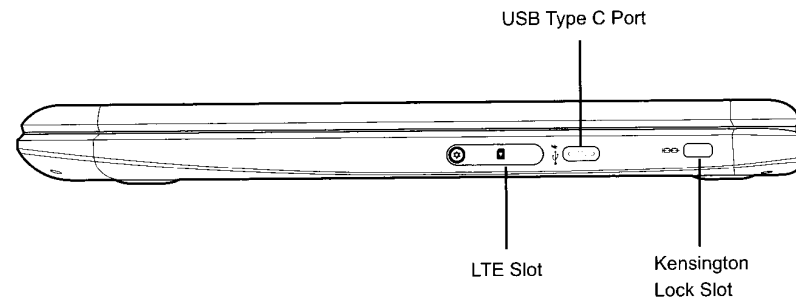

USB Type C Port

The USB Type C port allows you to connect Universal Serial Bus devices. It is small, compact, and reversible port.

Kensington Lock Slot

The Kensington lock slot allows you to secure your Chromebook to an immovable object with an optional security cable.

USB SKU:

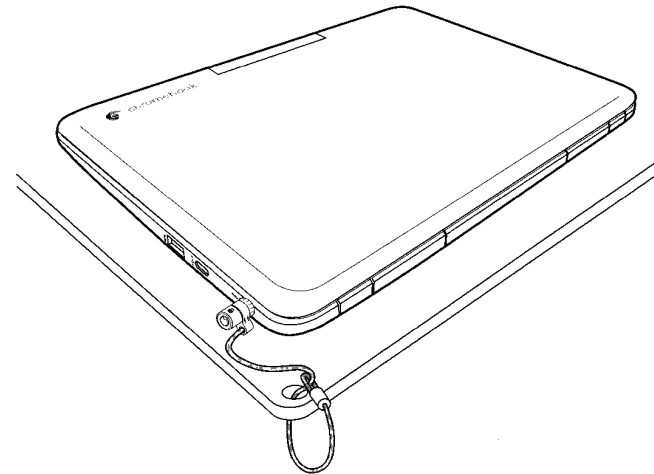

HDMI SKU:

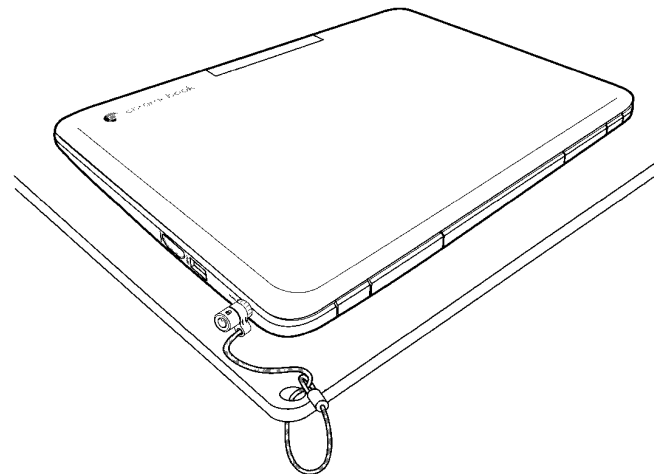

LTE SKU:

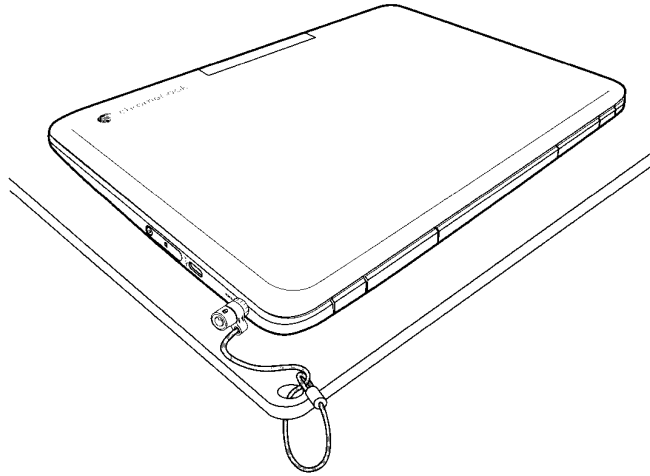

USB 3.0 Port (for USB SKU and HDMI SKU)

The USB 3.0 port allows you to connect Universal Serial Bus devices. It supports v3.0 of the USB standard, which allows data exchange rates as high as 4.8 Gb/s. USB 3.0 is backwards compatible with USB 2.0.

HDMI Port (for HDMI SKU)

The HDMI port allows you to connect a video device such as a television, a projector, or a VCR to your computer.

LTE Port (for LTE SKU)

Insert the SIM card to the LTE slot for mobile connectivity.

BACK OVERVIEW

The following is an overview of the back of the Chromebook.



BOTTOM OVERVIEW

The following is an overview of the bottom of the Chromebook.

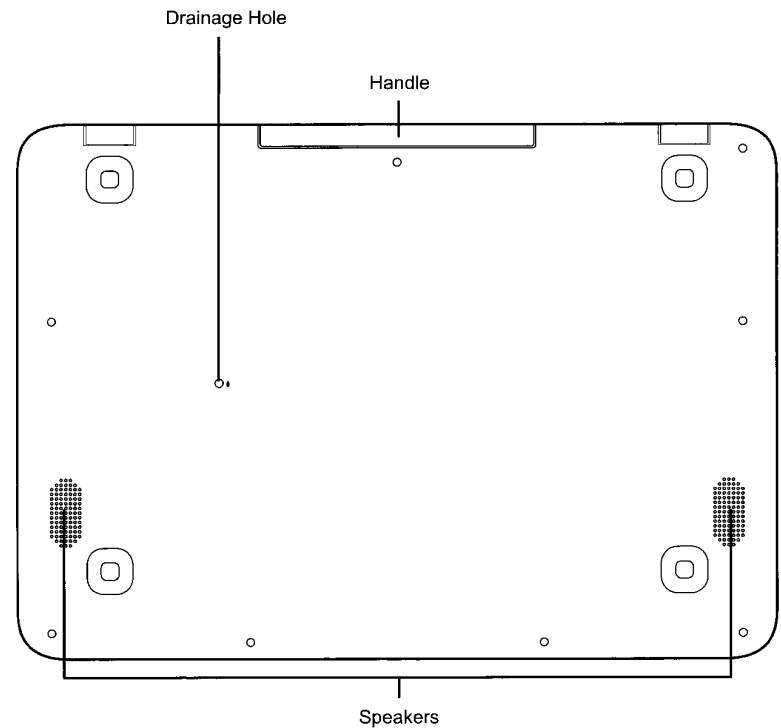

Drainage Hole

The drainage hole prevents the accumulation of liquid inside the keyboard by releasing any liquid that has entered the keyboard, such as liquid from condensation or accidental spillage.

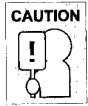

To prevent the accumulation of liquid inside the keyboard, make sure you do not block the drainage holes.

Handle

The integrated retractable handle allows you to carry the Chromebook conveniently.

Speakers

Speakers provide audio output for video and music playback.

GETTING STARTED

Power Sources

Your computer has two types of power source: a Lithium-Polymer battery or an AC adapter.

CONNECTING THE POWER ADAPTERS

The AC adapter provides power for operating your Chromebook and charging the battery.

Connecting the AC Adapter

1. Plug the DC output cable into the USB Type C port of your Chromebook.
2. Plug the AC adapter into an AC electrical outlet.

Switching from AC Adapter Power to Battery Power

1. Be sure that you have at least one charged battery installed.
2. Remove the AC adapter. Your Chromebook will automatically switch to battery power.



The Lithium-Polymer battery is not charged upon purchase. Initially, you will need to connect the AC adapter to use your Chromebook.

RECHARGING THE BATTERY

The Lithium-Polymer battery is recharged internally using the AC adapter. To recharge the battery, make sure the battery is installed and the computer is connected to the AC.

There is no “memory effect” in Lithium-Polymer batteries; therefore you do not need to discharge the battery completely before recharging. The charge times will be significantly longer if your Chromebook is in use while the battery is charging. If you want to charge the battery more quickly, put your computer into Suspend mode, or turn it off while the adapter is charging the battery.

Low Battery State

When the battery charge is low, a notification message appears. If you do not respond to the low battery message, the battery continues to discharge until it is too low to operate. When this happens, your Chromebook goes into Suspend mode. There is no guarantee your data will be saved once the Chromebook reaches this point.

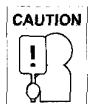

To protect your computer from damage, use only the power adapter that came with it because each power adapter has its own power output rating.

Once your Chromebook goes into Suspend mode as a result of a dead battery you will be unable to resume operation until you provide a source of power from an adapter. Once you have provided power, you can press the Suspend/Power On button to resume operation. In Suspend mode, your data is maintained for some time, but if a power source is not provided promptly, the power indicator stops flashing and the power goes out, in which case you have lost the data that was not saved. Once you provide power, you can continue to use your computer while an adapter charges the battery.

Starting Your Chromebook

POWER ON

The suspend/power on switch is used to turn on your Chromebook from its off state. For first time use, you must connect your AC adapter to the Chromebook and fully charge the internal Lithium-Polymer battery, once the battery charging status indicator has turned blue, you can power on your Chromebook by pressing the suspend/power on button located at the upper-right corner of the keyboard.

To power on your Chromebook after first use, just open the lid of the Chromebook. If the display panel is opened and your Chromebook is not powered on, press the suspend/power on button.















POWER OFF

If you need to take an extended break, press the suspend/power on button to lock the screen or simply close the lid of the Chromebook. To power off your Chromebook, press and hold the suspend/power on button or click on the Status tray on the lower-right corner of the screen and then click on the  button to completely shut down your Chromebook.

When you power on your Chromebook, it will display the main sign-in screen. All Google Accounts that have been added to your Chromebook will be displayed. Click the Google Account you want to sign-in with and enter your password, this will take you to your background wallpaper. If a fault is found, your computer will automatically take you to the recovery screen.

USING SHORTCUT KEYS

Your Chromebook has several shortcut keys along the top row of the keyboard that have various functions.

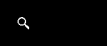
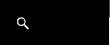
-  Go to the previous page in your browser history
-  Go to the next page in your browser history
-  Reload your current page
-  Enter Immersive mode, which hides the tabs and launcher
-  Enter Overview mode, which shows all windows
-  Decrease screen brightness
-  Increase screen brightness
-  Mute
-  Decrease the volume
-  Increase the volume
-  Search your apps and the web at the same time. On your Chromebook, this key is located on the left side, where you normally find the Caps Lock key on a traditional keyboard. To enable the Caps Lock key, press Alt +  key.
- Ctrl +  Capture a screenshot
- Ctrl + Shift +  Capture a partial screenshot
- Alt +  Turn **Caps Lock** on or off
-  + L Lock your screen

- Ctrl + Shift + q (twice) Sign out of your Google Account
- Ctrl + Shift + ? Display all keyboard shortcuts

USING THE TOUCHPAD

A touchpad pointing device comes built into your computer. It is used to control the movement of the pointer to select items on your display panel.

The touchpad consists of a cursor control, and a clicking area. The cursor control works the same way a mouse does, and moves the cursor around the display. It only requires light pressure from the tip of your finger. The clicking area is on the lower half of the touchpad that functions as mouse button. If tap-to-click is enabled, you can quickly tap the touchpad to perform the click function. To *right-click*, click the touchpad with two fingers. The actual functionality of the clicking area may vary depending on the application that is being used.

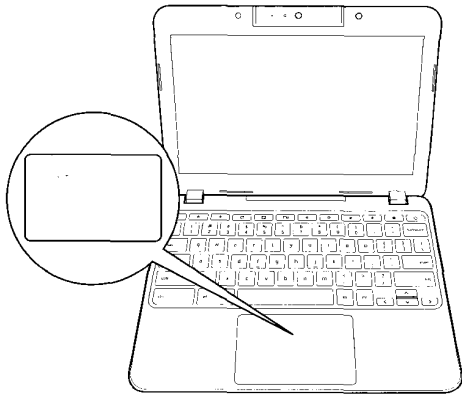

Clicking

Clicking means pushing and releasing a button. To left-click, move the cursor to the item you wish to select, press the clicking area once, and then immediately release it. To right-click, move the mouse cursor to the item you wish to select, tap on the touchpad with two fingers. You also have the option to perform the clicking operation by tapping lightly on the touchpad once.

Double-Clicking

Double-clicking means pushing and releasing the clicking area twice in rapid succession. To double-click, move the cursor to the item you wish to select, press the clicking area twice, and then immediately release it. You also have the option to perform the double-click operation by tapping lightly on the touchpad twice.

Dragging

Dragging means pressing and holding the clicking area, while moving the cursor. To drag, move the cursor to the item you wish to move. Press and hold the clicking area while moving the item to its new location and then release it. Dragging can also be done using only the touchpad. First, tap the touchpad once over the item you wish to move with one finger. Next, with a second finger move the object to its new location by moving the second finger across the touchpad, and then release both fingers.

Scrolling

Scrolling means navigating through a document or web-pages quickly without having to use the on-screen cursor to manipulate the up and down scroll bars. To scroll, simply place two fingers on the touchpad and move them up and down to scroll vertically, left and right to scroll horizontally. This is particularly useful when you are navigating through on-line pages.

TROUBLESHOOTING

Your computer is sturdy and subject to few problems in the field. However, you may encounter simple setup or operating problems that you can solve on the spot, or problems with peripheral devices, that you can solve by replacing the device. The information in this section helps you isolate and resolve some of these straightforward problems and identify failures that require service.

Identifying the Problem

If you encounter a problem, go through the following procedure before pursuing complex troubleshooting:

1. Turn off your Chromebook.
2. Make sure the AC adapter is plugged into your Chromebook and to an active AC power source.
3. Make sure that any card installed in the memory card slot is seated properly. You can also remove the card from the slot, thus eliminating it as a possible cause of failure.
4. Make sure that any devices connected to the external connectors are plugged in properly. You can also disconnect such devices, thus eliminating them as possible causes of failure.
5. Turn on your Chromebook. Make sure it has been off at least 10 seconds before you turn it on.
6. If the problem has not been resolved, contact your support representative.

Before you place the call, you should have the following information ready so that the customer support representative can provide you with the fastest possible solution:

- Product name
- Product configuration number
- Product serial number
- Purchase date
- Conditions under which the problem occurred
- Any error messages that have occurred
- Hardware configuration
- Type of device connected, if any

See the Configuration Label on the bottom of your Chromebook for configuration and serial numbers.

REGULATORY NOTICES

Manufacturer Information

Quanta Computer Inc.

No, 188, Wenhua 2nd Rd., Guishan Dist., Taoyuan City, Taiwan, R.O.C.

桃園縣龜山區文化二路 188 號

Tel: +886-3-327-2345

Made in China

USA

Federal Communications Commission Declaration of Conformity

Federal Communication Commission Interference Statement



This device complies with Part 15 of the FCC Rules. Operation is subject to the following two conditions:

- (1) This device may not cause harmful interference, and
- (2) This device must accept any interference received, including interference that may cause undesired operation.

This equipment has been tested and found to comply with the limits for a Class B digital device, pursuant to Part 15 of the FCC Rules. These limits are designed to provide reasonable protection against harmful interference in a residential installation. This equipment generates, uses and can radiate radio frequency energy and, if not installed and used in accordance with the instructions, may cause harmful interference to radio communications. However, there is no guarantee that interference will not occur in a particular installation. If this equipment does cause harmful interference to radio or television reception, which can be determined by turning the equipment off and on, the user is encouraged to try to correct the interference by one of the following measures:

- Reorient or relocate the receiving antenna.
- Increase the separation between the equipment and receiver.
- Connect the equipment into an outlet on a circuit different from that to which the receiver is connected.
- Consult the dealer or an experienced radio/TV technician for help.

FCC Caution

Any changes or modifications not expressly approved by the party responsible for compliance could void the user's authority to operate this equipment.

This transmitter must not be co-located or operating in conjunction with any other antenna or transmitter. This equipment complies with FCC RF radiation exposure limits set forth for an uncontrolled environment. This equipment should be installed and operated with a minimum distance of 20 centimeters between the radiator and your body.

Any changes or modifications (including the antennas) made to this device that are not expressly approved by the manufacturer may void the user's authority to operate the equipment.

Connections to Peripheral Devices

Connections to this device must be made with shielded cables with metallic RFI/EMI connector hoods to maintain compliance with FCC Rules and Regulations.

Manufacture is not responsible for any radio or television interference caused by using other than specified or recommended cables and connectors or by unauthorized changes or modifications to this equipment. Unauthorized changes or modifications could void the user's authority to operate the equipment.

European Union

CE Mark



Products with the Conformité Européene (CE) Marking, which indicates compliance with the applicable Directives.

This device has been tested and found to comply with the requirements set out in the Council Directive on the Approximation of the Laws of the Member States relating to Electromagnetic Compatibility (2014/30/EC) and in the Council Directive on the Harmonization of the Laws of Member States relating to Electrical Equipment Designed for Use within Certain Voltage Limits (2014/35/EU). This device has also been tested to comply with Radio equipment and telecommunications Terminal equipment (2014/53/EU) directive.

For manufacturer's Declaration of Conformity, please contact with Quanta Computer Inc.

WEEE and recycling statements

The Waste Electrical and Electronic Equipment (WEEE) Directive



This symbol means that the equipment must not be disposed of as unsorted municipal waste, in accordance with the EU directive for waste electrical and electronic equipment (WEEE - 2012/19/ EU). Disposing of WEEE together with normal waste may pose a risk to the environment and to human health, due to certain substances used in that equipment. Instead, it should be disposed of by returning it to the point of sale, or to a municipal recycling collection point.

Under the WEEE Directive, each EU Member State is responsible for achieving a high level of collection of WEEE for treatment, recovery and environmentally sound disposal.

Li-Polymer Battery Warning

This Chromebook contains a Li-polymer battery to power the clock and calendar circuitry.

Caution: Danger of explosion if battery is replaced incorrectly. Only qualified service technicians should replace and discard the battery. Replace only with the same or equivalent type recommended by the manufacturer. Discard used batteries according to the manufacturer's instructions.

Travel Notice



To reduce the risk of electric shock, fire or damage to the equipment, do not attempt to power the computer with a voltage converter kit sold for appliances.

ENERGY STAR model information



ENERGY STAR Program was created to help identify the best ways to save energy. The little blue label says this product, this home, this building or factory is doing the right things to save. And energystar.gov offers the most comprehensive resource available for energy efficiency advice and information.

It is pleased for us to offer our customers products with the ENERGY STAR qualified designation. You might find an ENERGY STAR mark affixed on your Chromebook or displayed on the power setting interface. This device has been designed and tested to conform to the ENERGY STAR program requirements for computers.

It is greatly users can help reduce the consumption of electricity by using ENERGY STAR qualified products and taking advantage of the power-management features of the computers.

For more information about ENERGY STAR, go to:
<http://www.energystar.gov>

It is pleased for us to encourage you to make efficient use of energy an integral part of your day-to-day operations. To help in this endeavor, it has preset the following power-management features to take effect when your computer has been inactive for a specified length of time:

Power plan: Default

- Turn off the display: After 8 minutes
- Put the computer into sleep: After 30 minutes

To awaken your computer from sleep mode, open the computer cover.

Attention: Teachers, Parents and Adult Supervisors in Safety Instructions

This Chromebook is intended for use as a child development tool primarily by children, 6 years of age or above. There must be supervision by an adult. It is a must to have a thorough explanation to children on safe and proper handling of the NL71/ NL71-L/ NL71CT/ NL71CT-L models, power supply, battery pack, and power cord.



Choking Hazard – Small parts. Not suitable for children under age 3.

- For ITE with power supplies not intended to be handled by children: As with all electrical products, precautions should be observed during handling and use to prevent electric shock. The power supply (adapter) should not be handled by the children.
- The *NL71/ NL71-L/ NL71CT/ NL71CT-L* should not be placed on the bare skin (lap) of the child for long periods. The laptop should be placed on another surface, like desk tabletop, if intending to use it for more than a few minutes.
- The *NL71/ NL71-L/ NL71CT/ NL71CT-L* (including power supply and battery pack, as applicable) should not be left in the rain or subjected to exposure to water. If cleaning is necessary do not immerse in water; wipe clean with damp cloth.
- The *NL71/ NL71-L/ NL71CT/ NL71CT-Ls* (including power supply and battery pack, as applicable) should not be dropped, crushed (stepped on) or otherwise abused.
- The children should be careful with the interconnect cable (wiring) between the power supply (adapter) and *NL71/ NL71-L/ NL71CT/ NL71CT-L*, in particular as a potential trip hazard.
- An adult should inspect the *NL71/ NL71-L/ NL71CT/ NL71CT-L* (including power supply and battery pack, as applicable) periodically for damage, and replace if necessary. Similarly, if a child notices damaged/broken parts, this should be reported to the teacher/parents/adult supervisors immediately so that the damaged parts can be replaced.

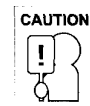

ELECTRICALLY OPERATED PRODUCT. Not recommended for children under 3 years of age (or other intended age range). As with all electrical products, precautions should be observed during handling and use of electrical products to reduce the risk of electric shock.

SPECIFICATIONS

LCD	16:9/HD (1,366 x 768)/Flat/Glossy type/LED backlight/LVDS and eDP interface
Platform	Intel Gemini Lake-Refresh
Video	UMA
Audio	Two internal speakers One digital microphone on the camera One audio combo jack (Headphone & Microphone)
Memory	Supported up to 8G LPDDR4 1600
Storage	eMMC 16GB/32GB (option)
I/O Ports	<p>USB SKU:</p> <ul style="list-style-type: none"> Two USB 3.0 port Two USB Type C ports One 2-in-1 memory card reader (SD/MMC) One audio combo jack (headphone-out & microphone-in) <p>HDMI SKU:</p> <ul style="list-style-type: none"> One USB 3.0 port One HDMI port <p>Two USB Type C ports</p> <ul style="list-style-type: none"> One 2-in-1 memory card reader (SD/MMC) One audio combo jack (headphone-out & microphone-in) <p>LTE SKU:</p> <ul style="list-style-type: none"> One USB 3.0 port One LTE slot Two USB Type C ports One 2-in-1 memory card reader (SD/MMC) One audio combo jack (headphone-out & microphone-in)
Camera	HD (720P) Camera integrated with LED indicator, rotation camera
Wireless	Intel® Dual Band WL/BT 802.11AC
Battery	Li-Ion 3 cells, 3320mAh/cell, 38WH, battery life up to 12 hrs
Power	15V DC, 2.A 30W adapter
OS	Chrome OS
Magnification Lens	N/A
Handle	Yes
TPM	N/A
Dimensions	292 × 206 × 19.7 mm (including the handle)
Weight	1.33 kg (with LCD and battery)